

Data Sheet

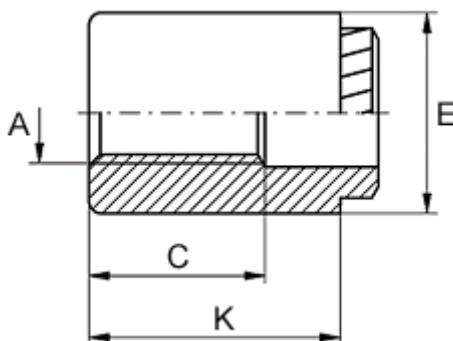

Article number: 12513600020500
Description: KLEE-coil 513 600 020.500
M2 Stainless 1.4305

Measures



Female thread A	= M2
Height K	= 13
Hole diameter +0.1	= 3.7
Min distance to edge	= 2.2
Min material thickness	= 1.5
Outer diameter E	= 6
Thread length	= 9